

Key Data

2 x 3 x 400A AC at 500V AC, air cooled

General Information

Stack with IGBT's, heatsinks, capacitors, drivers and sensors for several inverter applications. These are only technical data! Please read heedful the complete documentation and attend the adopted design environment! Especially the EMC environment and the controller functionality are important.

Topology	DC Link + 2B6I		Unit 1	Unit 2
Load Type	Resistive, inductive load			
Cooling	Forced air, Fan excluded			
Target Application	Solar			
Extra	Available in Master [M] or Slave [S] Configuration			
Driver core	Scale Driver			
Monitors	Current-, Voltage-, Temperature-Monitoring			
Module (Unit1)		n.a.		
Module (Unit2)	IGBT	6x FF800R12KL4C		
Interface	Electrical, opt. optical			
Standards	EN50178, UL94, prepared for UL508C			
Product ID (eupec)	Master 24967 Slave 24969			
Drawing No.	38000020_MB			
Circuit Diagram No.	57000002			

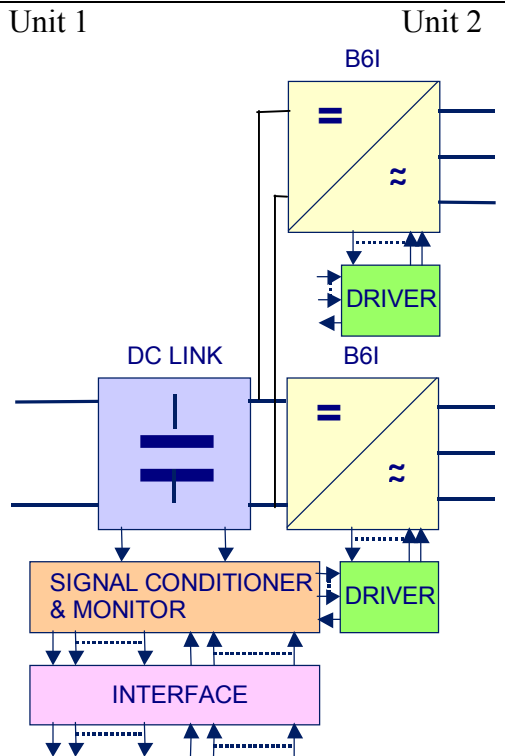

Electrical Data

	Parameter		Min.	Typical	Max.	
Dedicated Line Voltage	For Isolation Management	VLine		500		VRMS
DC Link Voltage		VDC	275	675	880	Vav
DC Link Over Voltage Shutdown	Within 100µs			VDCmax		V
DC Link Current	At IUnit2, VUnit2, cos φUnit2	IDCLink Input	800	890		Aav
Voltage Unit1		VUnit1		-		VRMS
Continuous Current Unit1	ϑ=ϑair_inlet	IUnit1			-	ARMS
Short-time Current Unit1	10s, every 180s, initial load = IUnit1	IUnit1_10			-	ARMS

Pulse Current Unit1	Sine half wave 20ms				-	A _{peak}
DC Current at Unit1	No rotating field, $\vartheta = \vartheta_{\text{air_inlet}}$	I _{Unit1_DC}			-	A _{av}
Over Current Shutdown Unit1	Percentage of I _{Unit1} . within 15 μ s			-		%
Switching Freq. Unit1		f _{sw1}			-	Hz
Power Losses Unit1	$V = V_{\text{unit1_min}}$, $I = I_{\text{Unit1}}$, f _{sw} =f _{sw1}	P _{loss1}		-		W
Voltage Unit2	Depending on Controller	V _{Unit2}		500	550	V _{RMS}
Displacement factor		cos_ φ Unit2	-0,9		+0,9	
Continuous Current Unit2	$\vartheta = \vartheta_{\text{air_inlet}}$, $\vartheta_{\text{chip}} \leq 125^{\circ}\text{C}$ f _{Unit2} >5Hz Both B6I connected in parallel (1U1 ->2U1..)	I _{Unit2}			800	ARMS
Short-time Current Unit2	$\vartheta_{\text{water_inlet}} \leq 40^{\circ}\text{C}$, 10s, every 180s, initial load = I _{Unit2}	I _{Unit2_10}			960	ARMS
Pulse Current Unit2	Sine half wave 20ms, starting from I _{Unit2} .	I _{Unit2peak}			-	A _{peak}
DC Current at Unit2	No rotating field, $\vartheta = \vartheta_{\text{air_inlet}}$	I _{Unit2_DC}			0,4* I _{Unit2}	ADC
Over Current Shutdown Unit2	Percentage of I _{Unit2} . within 15 μ s			125		%
Switching Freq. Unit2		f _{sw2}			3000	Hz
Power Losses Unit2	$I = I_{\text{Unit2}}$, f _{sw} =f _{sw2}	P _{loss2}		6521		W
Power Losses (PCB and Capacitor)		P _{loss_aux}			400	W
Filter resistors at Output Unit2	Applicable for Sine wave filters (damping, optionally)	R _{Filter}		-		Ohm
		PR _{Filter}		-		Watt
Auxiliary Voltage		V _{aux}	18	24	30	V _{av}
Auxiliary Power Demand	V _{aux} =24 V _{av} , to feed with B6U	P _{aux}		80		W
EMC Test	According EN61800-3 at named interfaces	Power	V _{Burst}		2	kV
		Control	V _{Burst}		1	
		Aux (24V)	V _{Surge}		1	kV
Insulation Test Voltage	According EN50178 f=50Hz, t=1min	V _{isol}		1,8		kV _{RMS}

Important Component Data

DC Link Capacitor		CDC		23,5		mF
DC Link Capacitor		Type	Elcap			
Capacitor Design	Load cycle for: Wind	LTD		-		Year

Lifetime (eupec approximation)	Load cycle for: Solar	LTD		t.b.d.		Year
	Load cycle for: Industrial Drive ($\vartheta_{air}=35^{\circ}C$, $I=0,8$, Duration=24h/Day)	LTD		-		Year

Requirements to the Power Source

Assumed Inductance Of Feeding Power Source	(Necessary inductance not included, feeded by B6U)	LFeed		80		μH
--	--	-------	--	----	--	---------

Fan Data (requirements when not implemented)

Fan Type	Assumed		2pcs Ziehl-Abegg RF22P- 2DK.3F.1R			
Fan Voltage		VFan		400		VRMS
Fan Frequency		fFan		50		Hz
Fan Current		IFan		1,95		ARMS
Fan Air Pressure	Assumed	Δp_{AirFan}		700		Pa

Controller Interface Data

Driver	See Data Sheets	PCB	TR10x			
Paralleling Interface	Master (only first B6I)	PCB	SAD101			
	Slave		-			
	See Data Sheet					
Optical Interface	Master (only first B6I) (optional)	PCB	OEA101			
	Slave		-			
	See Data Sheet					
Digital Input Level	Resistor to Gnd (1,8k) High = on min 15mA	Vin	0		15	V
Digital Output Level	Open collector Low = ok max 15mA	Vout	0		15	V
Analog Current Outputs Unit1	Load max 1mA at IUnit1			-		V
Analog Current Outputs Unit2	Load max 1mA at IUnit2			4		V
Analog DC Link Voltage Output	Load max 1 mA At VDCmax	VDCout		9		V
Analog Temperature Out	Load max 1mA At $\vartheta_j=125^{\circ}C$	V ϑ_{out}		9		V
Optical Input Level	optionally		12			μW
Optical Output Level	optionally				60	μW

Requirements to the Controller

EMC Protection	According EN61800-3 at auxiliary power and control interface		1			kV
EMC Environment			Shielding concept with TE (True Earth) separated from PE, HF conform installation			
Drive Pulse Time		ton_min	10			μs
Block out Time		tpause	10			μs
Over Voltage Shutdown Reaction Time	After over voltage message by ModSTACK interface				50	μs
Over Current Shutdown Reaction Time	After over current message by ModSTACK interface				10	μs

Mechanical Data

Air Velocity	$\vartheta_{Air}=20^{\circ}C$ $P_{air}=1013\text{ hPa}$ Dry- and dustfree, measured outside of heatsink. According DIN 41882	vAir		12		m/s
Air Flow/ heatsink		dV/dtAir	-	2200		m ³ /h
Air Pressure Drop/ heatsink		ΔpAir		700		Pa
Water Flow/ heatsink	According Coolingwater Specification from eupec for copper tubes	dV/dt Water	-			l/min
Water Pressure Drop/ heatsink		ΔpWater		-		Pa
Water connection						
Dimensions	Width x Depth x Height		1090	600	305	mm
Mass	Approximation			101		kg
Storage Temperature Range		ϑstor	-40		+65	°C
Operating Temperature range (PCB and Capacitor)	Minimal 0 °C for optional optical interface	ϑop	-25 (0)		+55	°C
Cooling Air Inlet Temperature (Heatsink)		ϑair_inlet	-25		+40	°C
	Heatsink temperature > -25°C		-40			
Cooling Water Inlet Temperature (Heatsink)		ϑwater_inlet	-		-	°C
Cooling Air Velocity (PCB and Capacitor)		vAir_PCB	2			m/s
Air Pressure	Standard atmosphere	pAir	900		1100	hPa

ModSTACK



Data Sheet: 2B6I 500/800-400G M, S

Preliminary Data

Humidity	No Condensation	Rel. F	0		95	%
Installation Height			0		1000	m
Vibration	EN60068-2-6, Fc 10..59Hz 0,075mm				10	m/s ²
Permanence Vibration	EN60068-2-6, Fc 10-150Hz, 20 Cycles				20	m/s ²
Shock	EN60068-2-27, Ea Half sine 11ms, 3 pulses				100	m/s ²
Protection Degree				IP00		
Pollution Degree				2		
Over Voltage Category				III		

Derating Curves (IGBT Part)

Current derating at low rotating field frequency (f_0). **Maximal 100% current is allowed.**

$\cos(\phi) = 0.64$, (motor)
 $\Theta_{air} = 40^\circ\text{C}$

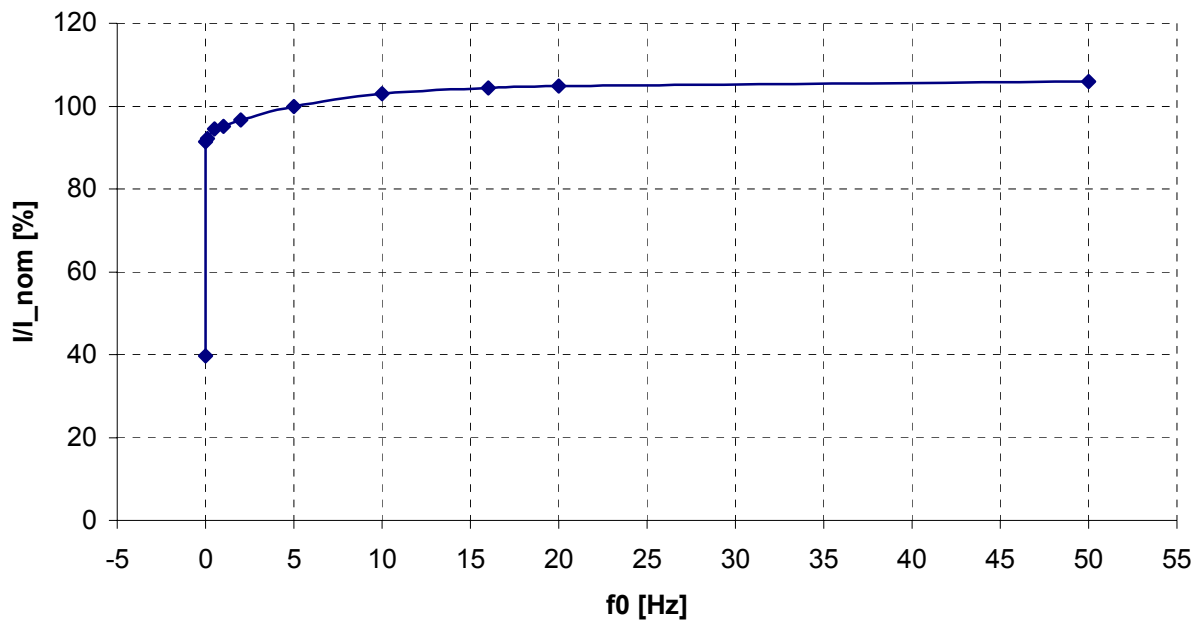

cos(phi) = -0.64, (generator)
Theta_air = 40°C

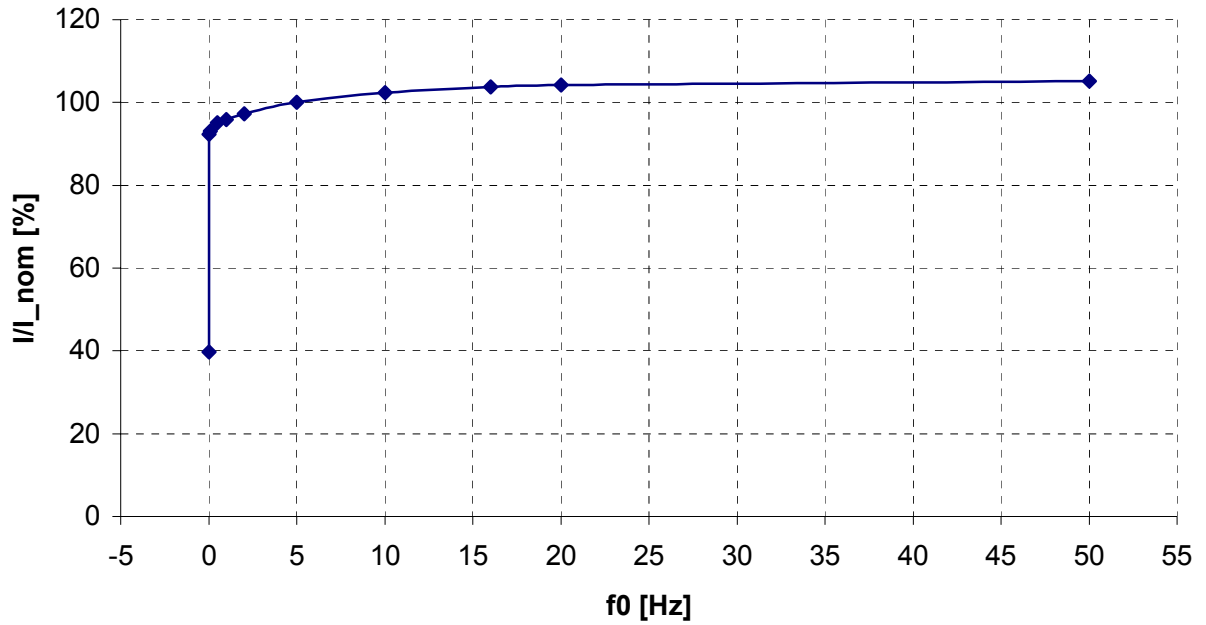

Current derating at different switching frequencies. See datatable for nominal switching frequency. In this drawing 2500Hz is assumed. **Maximal 100% current is allowed.**

**IGBT, $\cos(\phi) = 0.64$
 $\Theta_{air} = 40^\circ\text{C}$**

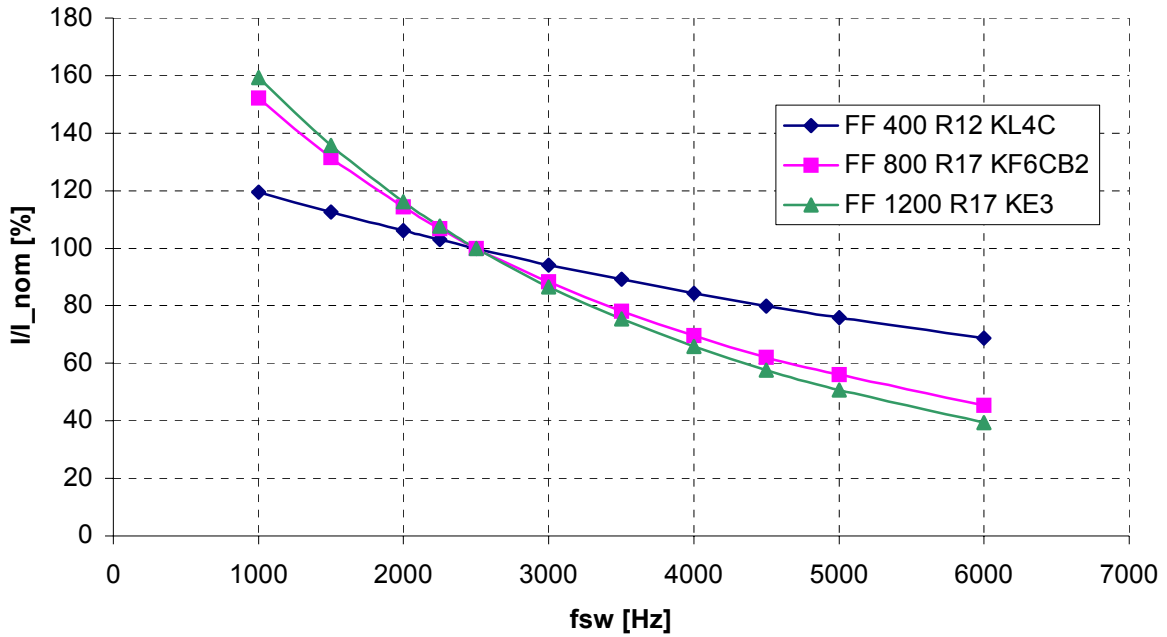

**Diode, $\cos(\phi) = 0.64$
 $\Theta_{air} = 40^\circ\text{C}$**

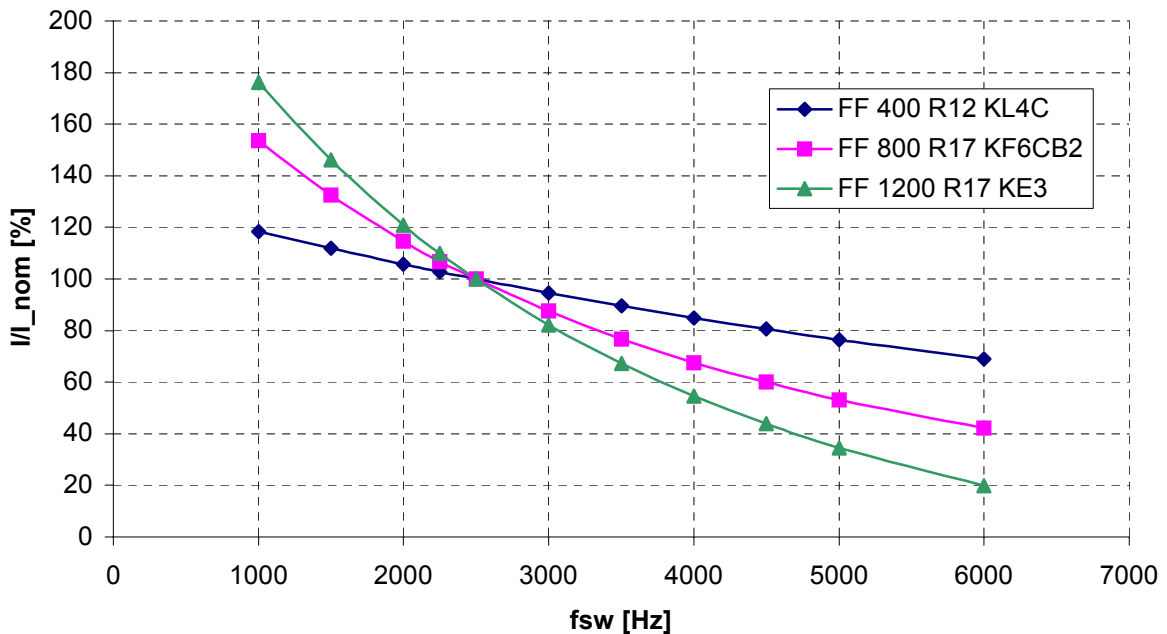

IGBT, $\cos(\phi) = -0.64$
 $\Theta_{air} = 40^{\circ}\text{C}$

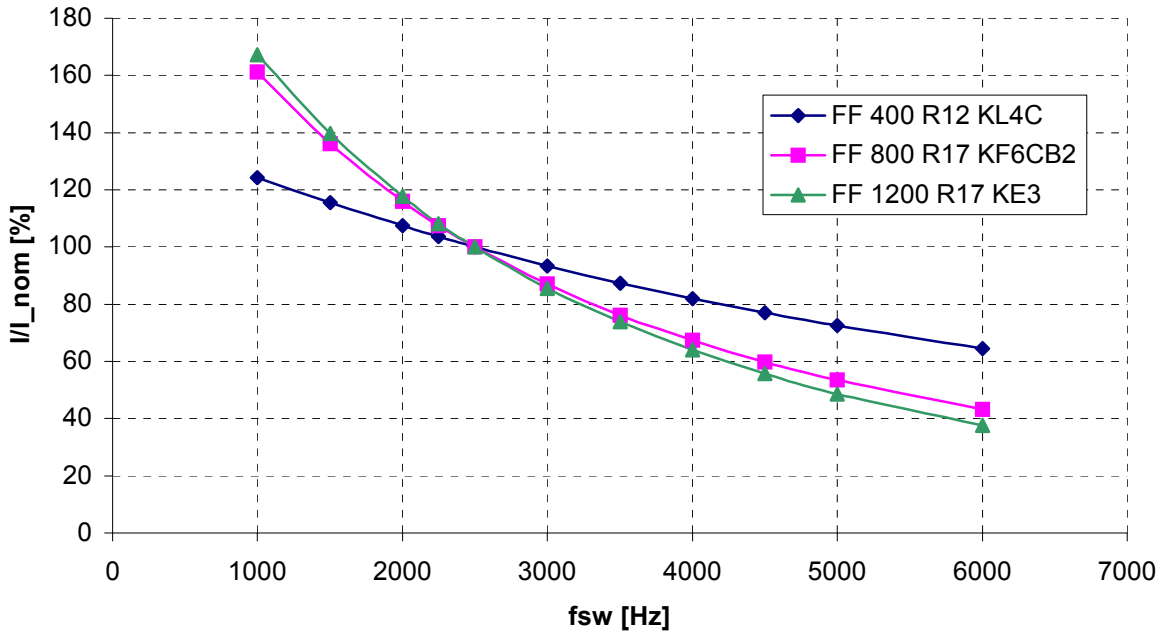

Diode, $\cos(\phi) = -0.64$
 $\Theta_{air} = 40^{\circ}\text{C}$

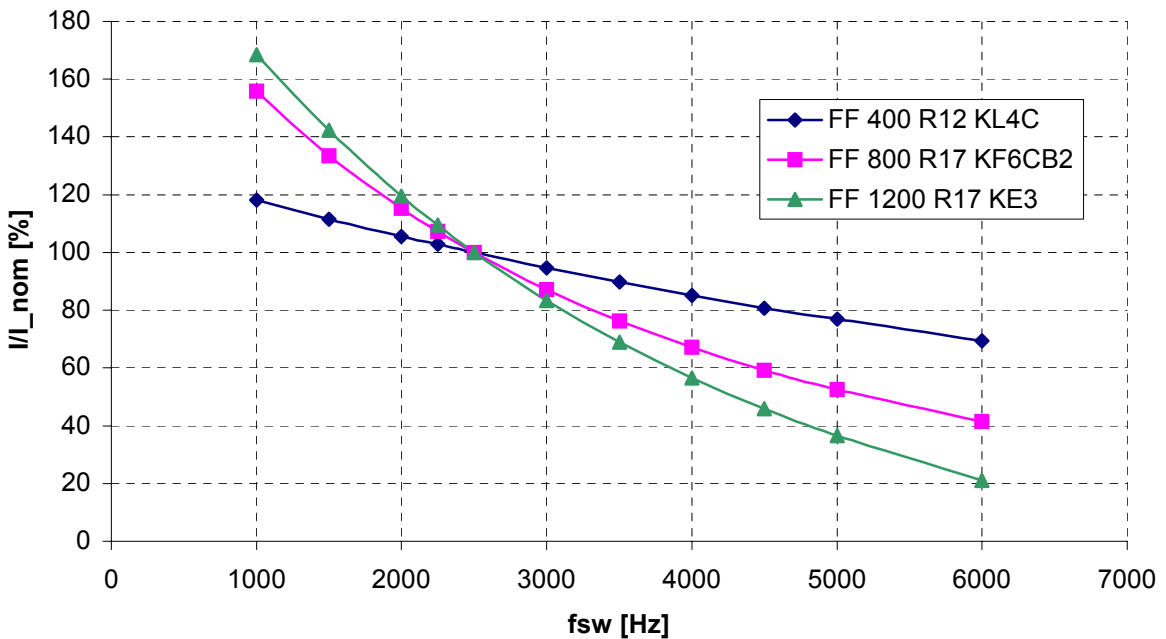

Miscellaneous

This technical information specifies semiconductor stacks but promises no characteristics. It is valid in combination with the belonging technical notes.

This document may be changed without prior notice.

Warning!

Prior to installation and commissioning all safety notices and warnings and all warning signs attached to the equipment have to be carefully read. Make sure that all warning signs remain in a legible condition and missing or damaged signs are replaced.

The safety instructions have to be strictly adhered to.

The manual contains detailed information on all technical topics with regard to the eupec ModSTACK. For further details regarding publications of the eupec ModSTACK and information on other publications in the area of ModSTACKs please contact your nearest eupec branch or visit our website: <http://www.eupec.com>.

©eupec GmbH 2003. All rights reserved

Prepared by	J.Schiele	2003-04-03	Date of publication	
Approved by	H.Nübel	2005-04-13	Revision	2, 13.04.2005

2B6I_/_/_-_-F/G/W
 ModSTACK Size 3
 38000032 MB

